

Anbauanleitung Seilwindenstoßstange *Installation instruction winch bumper* **Land Rover Defender**

Best.-Nr.: 1 -336050

AL: 1132 – 02



Hier sehen sie den fertig montierten Seilwindenanbausatz.
Bevor sie mit der Montage beginnen, lesen sie bitte diese Anleitung und das Benutzerhandbuch der Seilwinde gut durch.

Achtung:

Bei Fahrten im öffentlichen Straßenverkehr muß das Rollenseilfenster mit einer Kunststoffabdeckung abgedeckt werden.

Here you see the ready fitted mounting kit. Before you start installing, please read and understand this instruction and the users manual of the winch.

Stückliste , parts list

Seilwindenstoßstange, *winch bumper* Land Rover Defender

Best.nr.: 1 - 336050

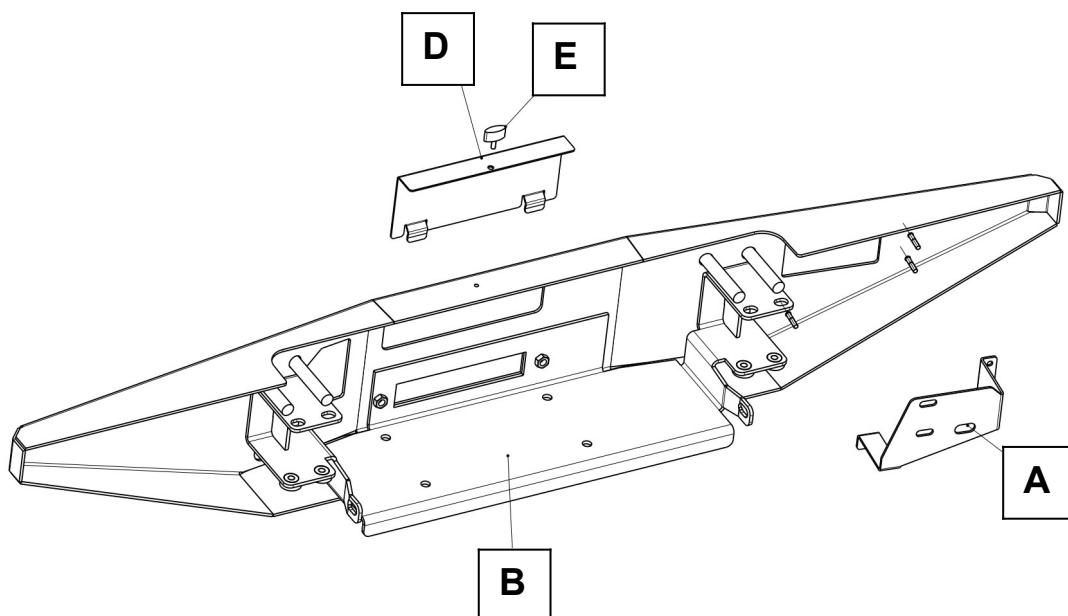

1 x Seilwindenstoßstange (B)

1 x Schaltkastenhalter (A)

1 x Kennzeichenhalter (D)

1 x Rändelschraube M 6 (E)

**1 x 3500mm Kabel 35² (rot) mit
2 x Kabelschuh 35² x 8**

**1 x 3500 mm Kabel 35² (schwarz) mit
2 x Kabelschuh 35² x 8**

1 x Anbauanleitung AL 1132

1 x Gutachten

3 x Mutter M 6

3 x Federring M 6

3 x U-Scheibe M 6

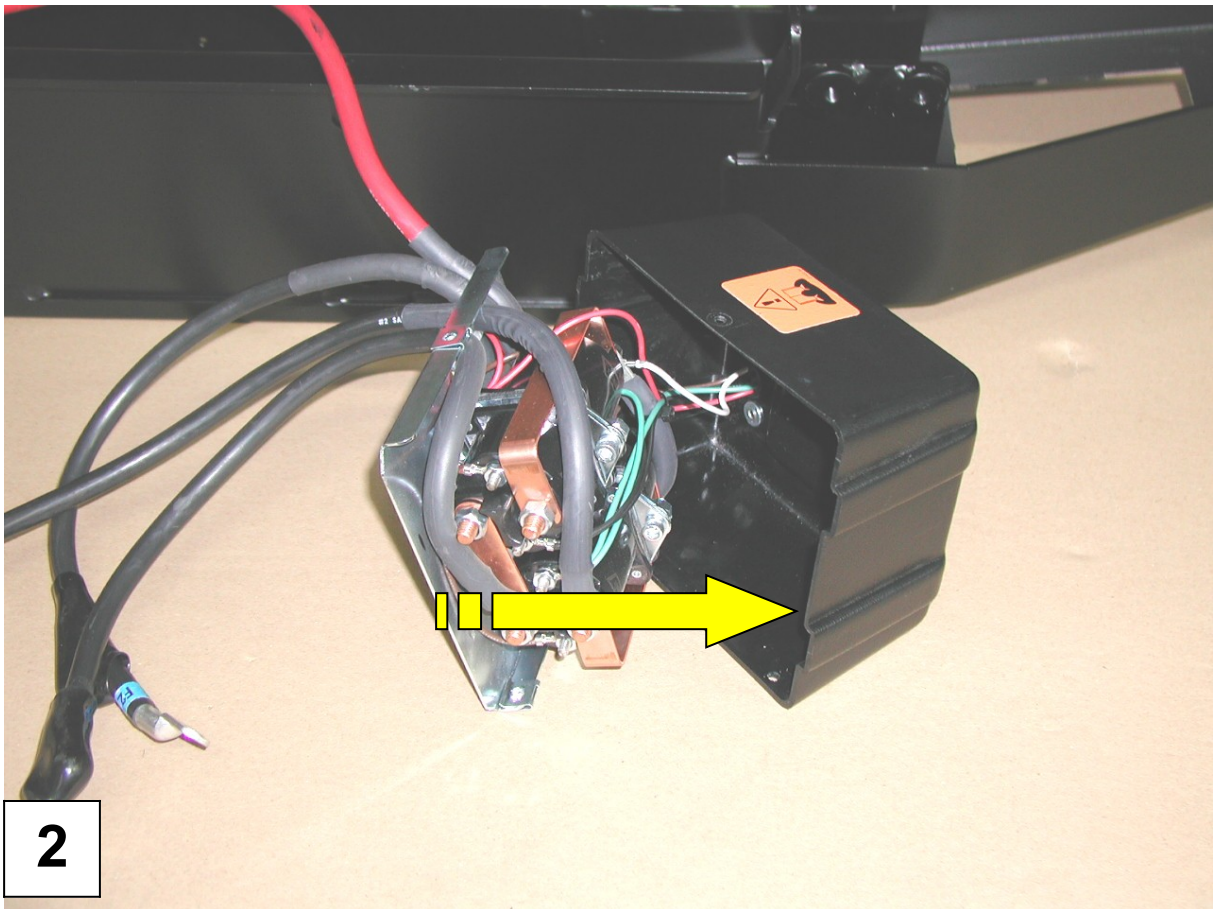

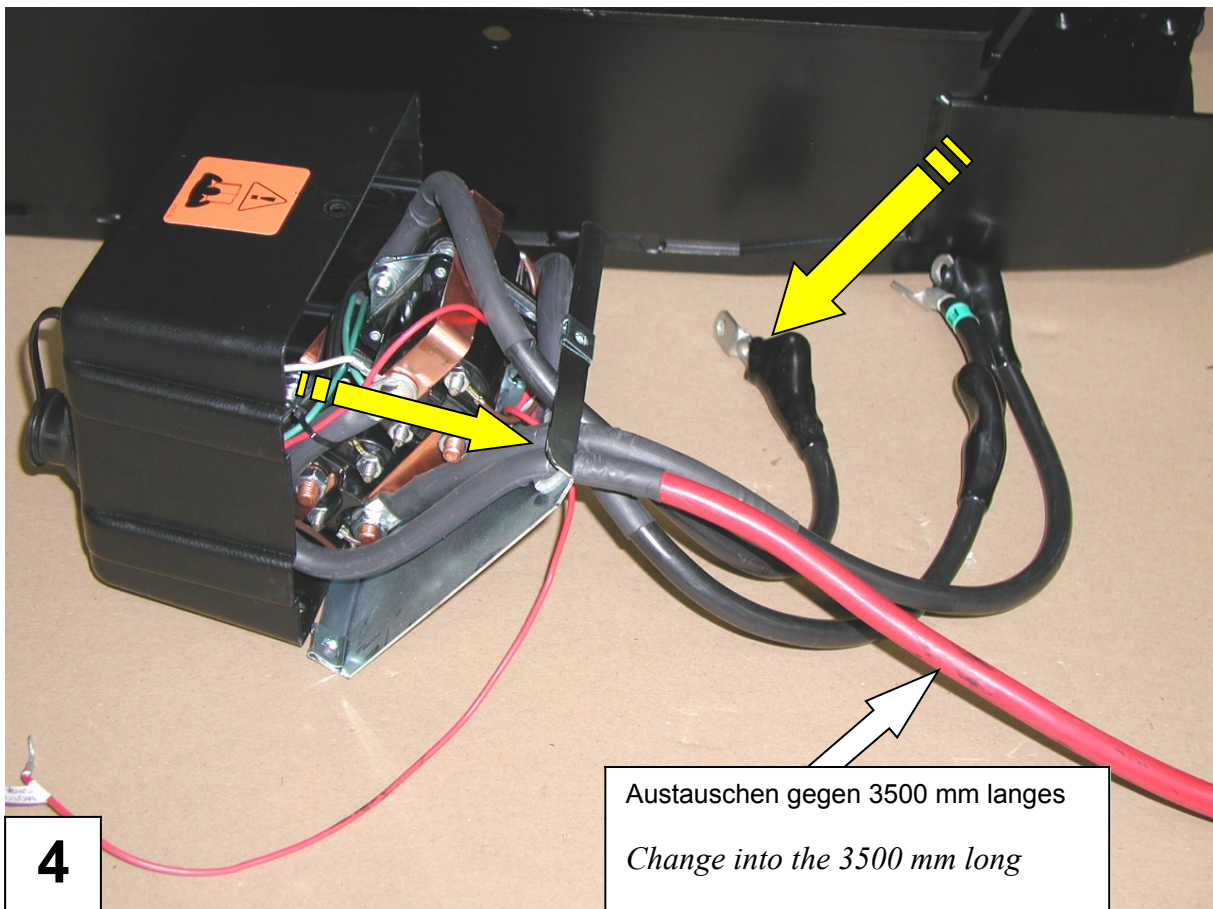
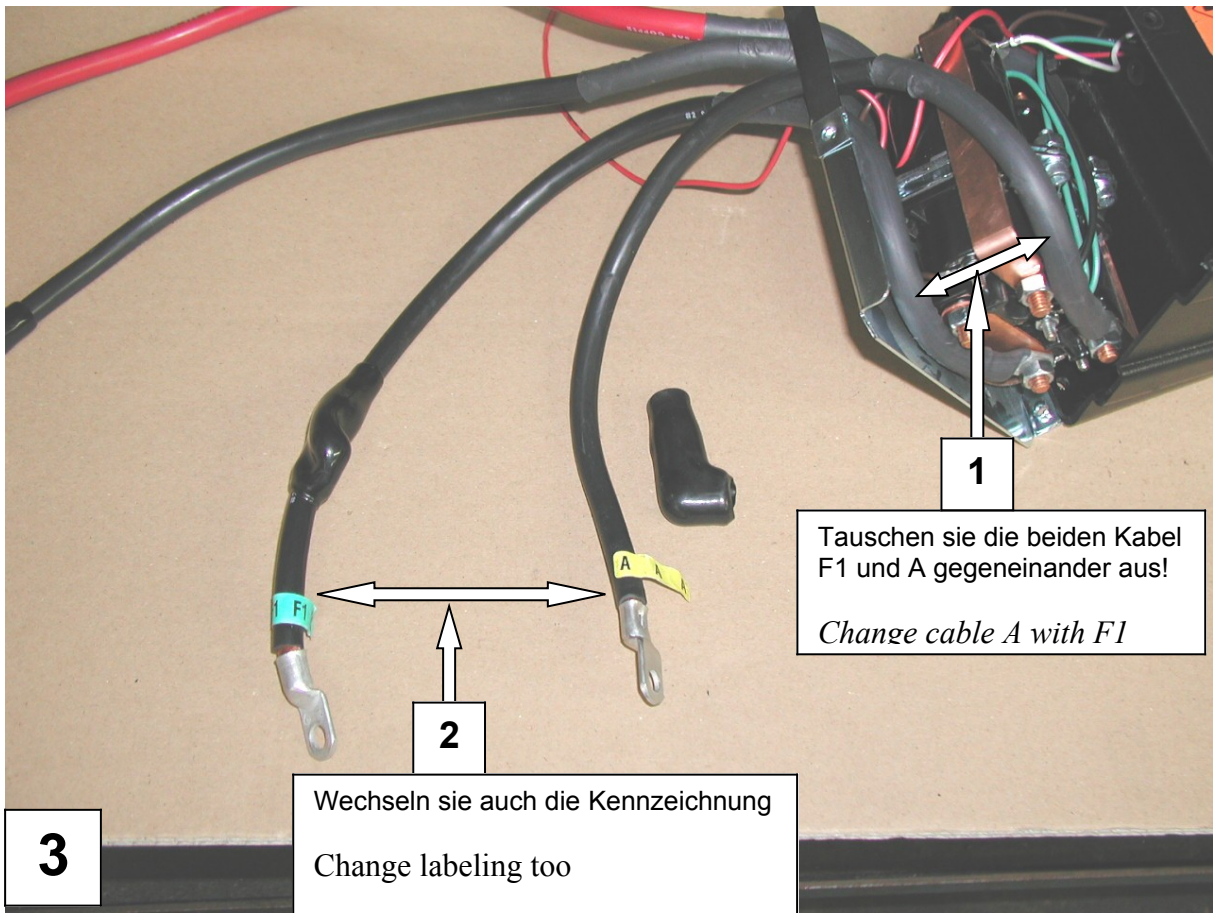

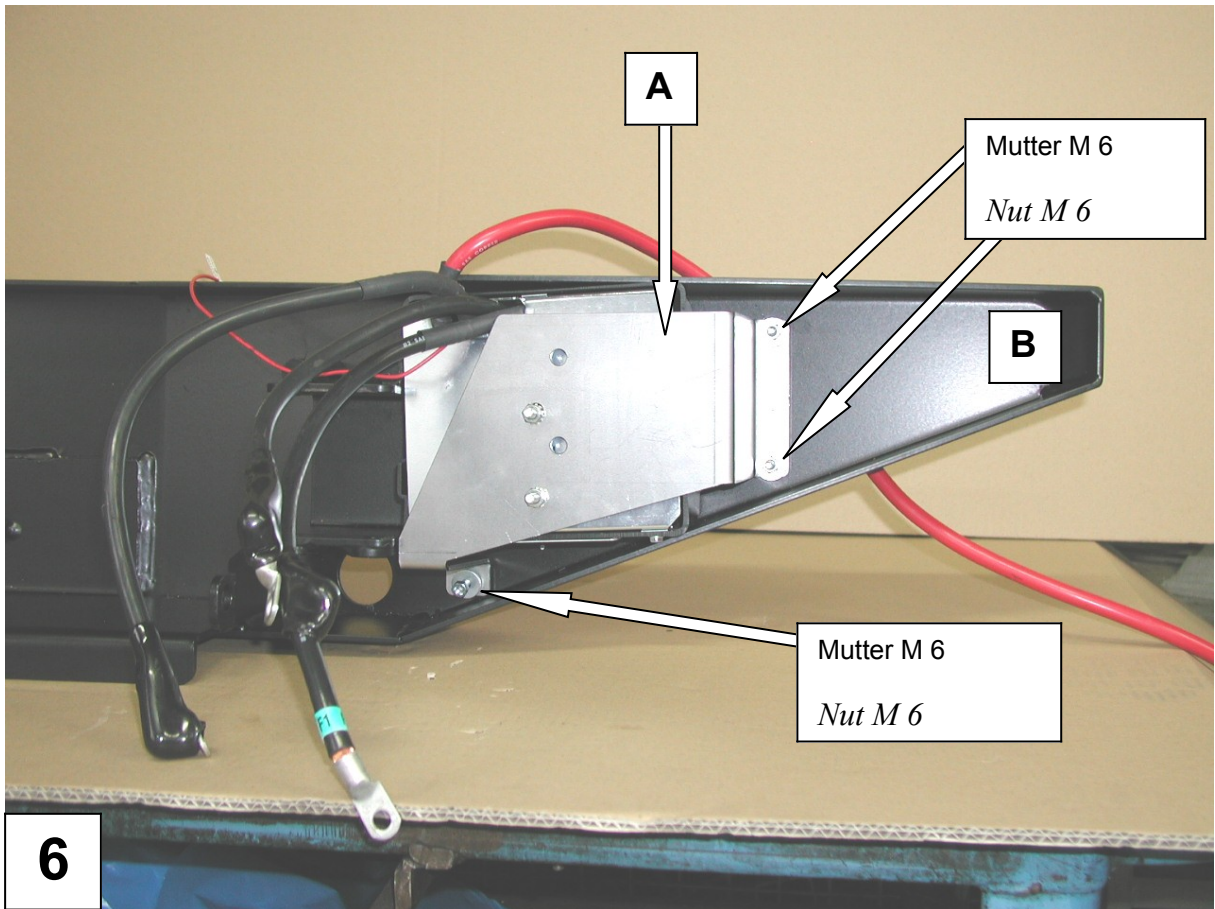
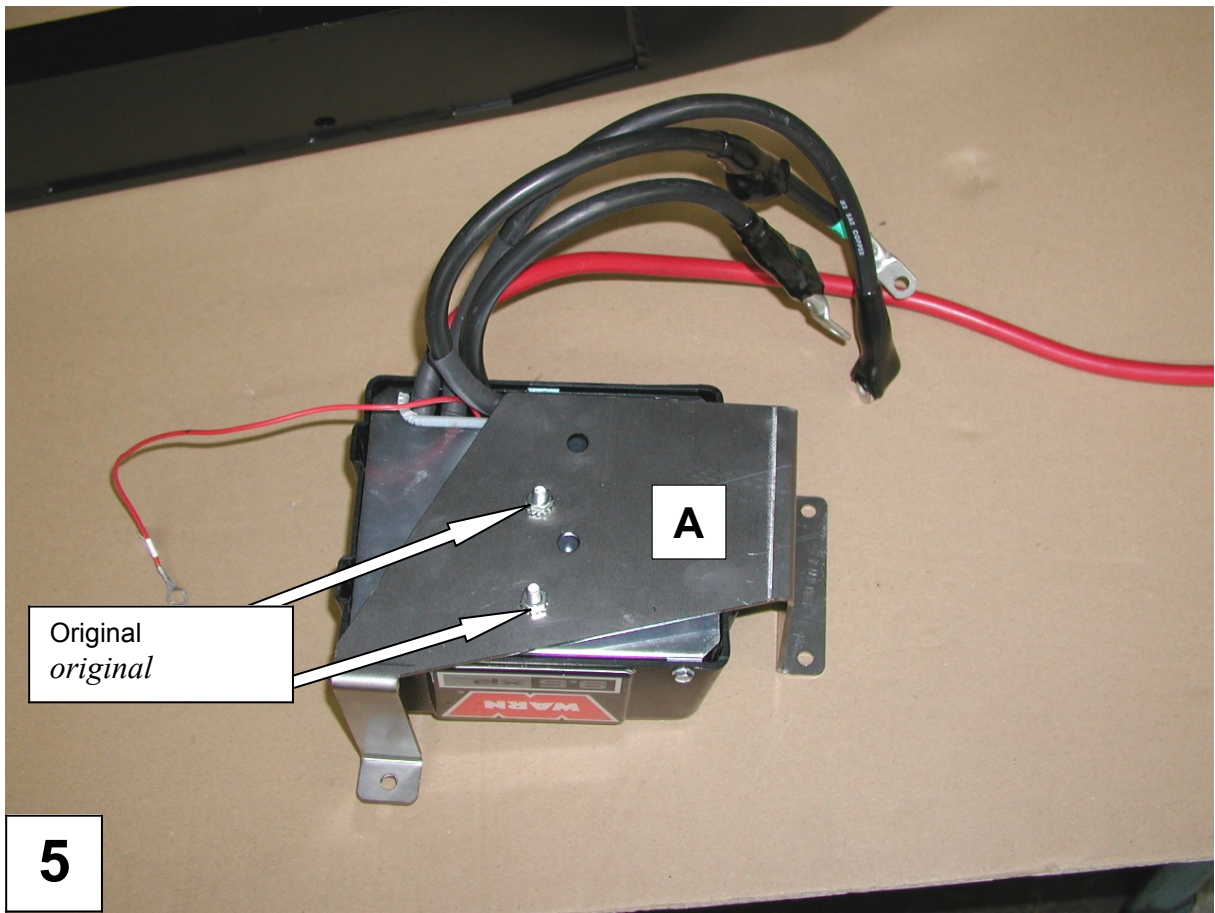

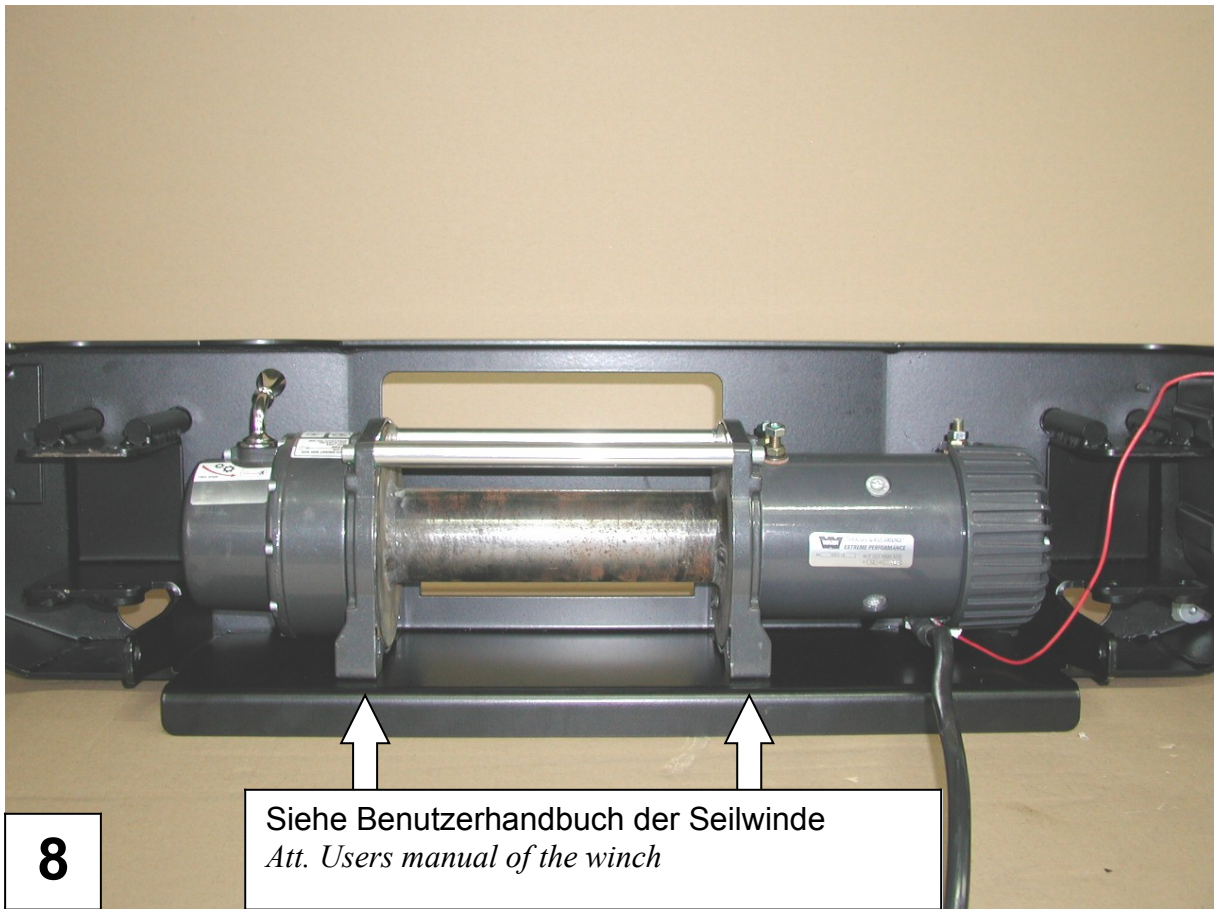
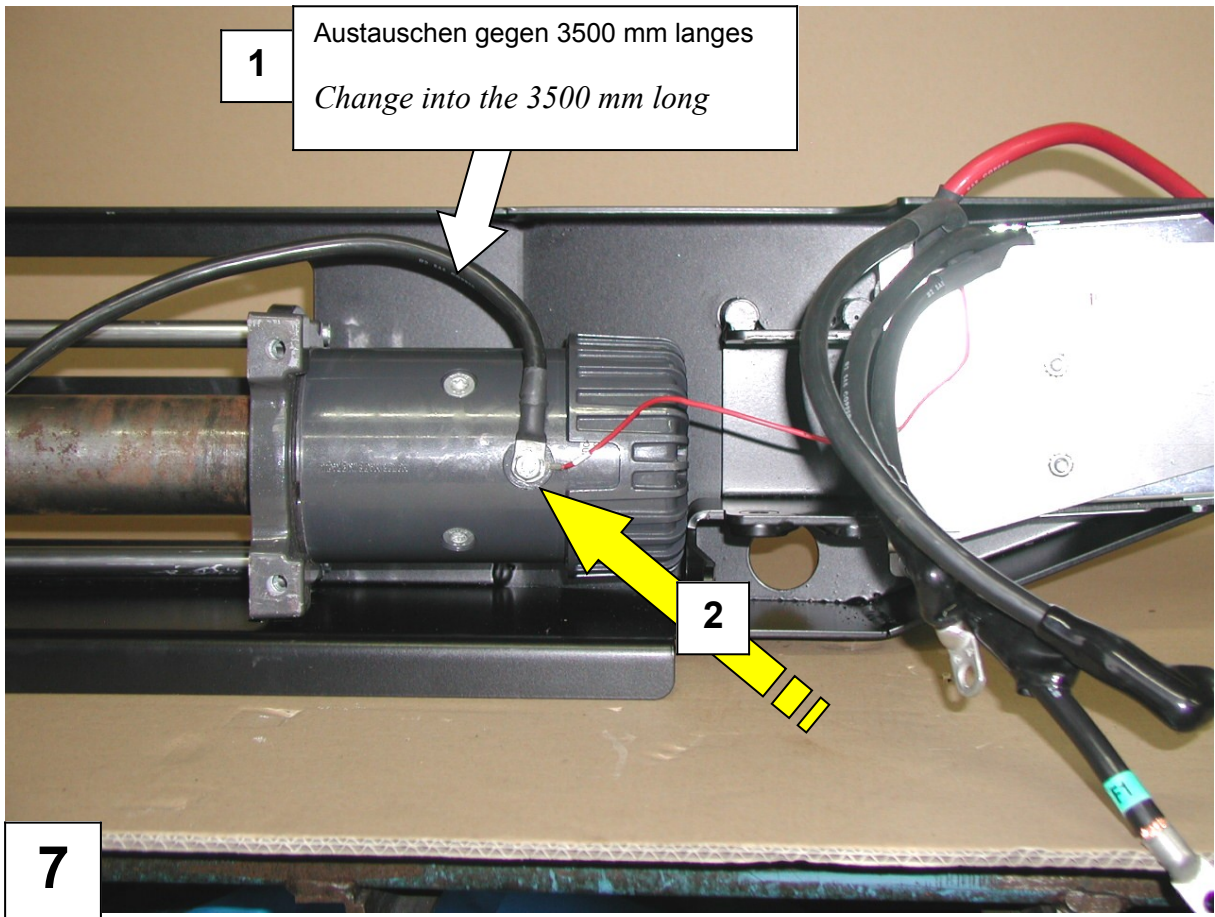

Siehe Benutzerhandbuch der Seilwinde
Att. Users manual of the winch

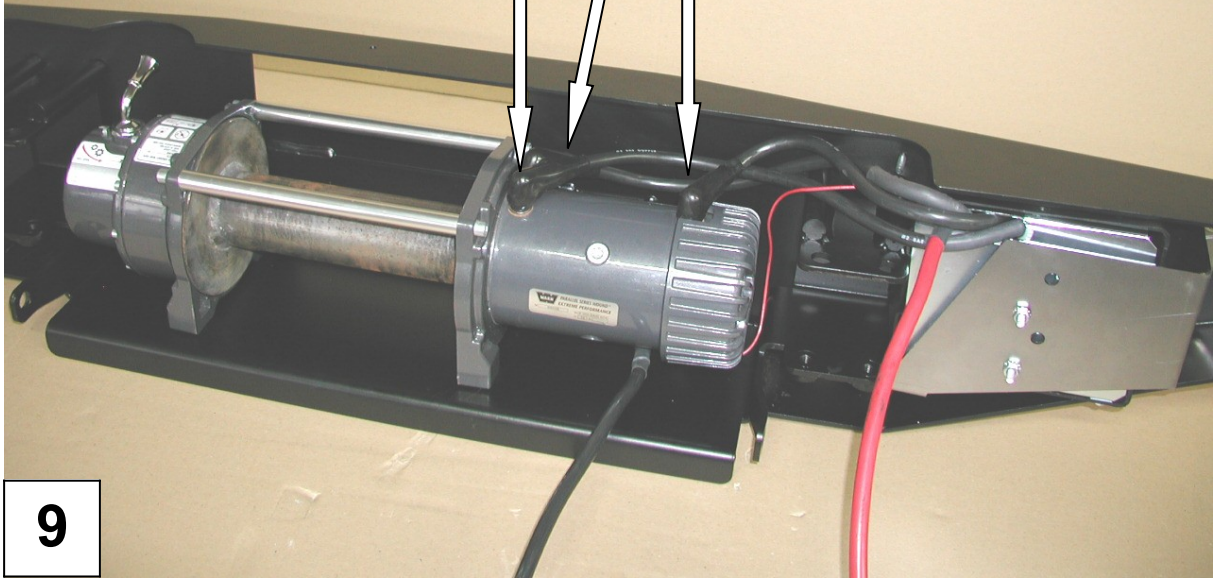

9



10

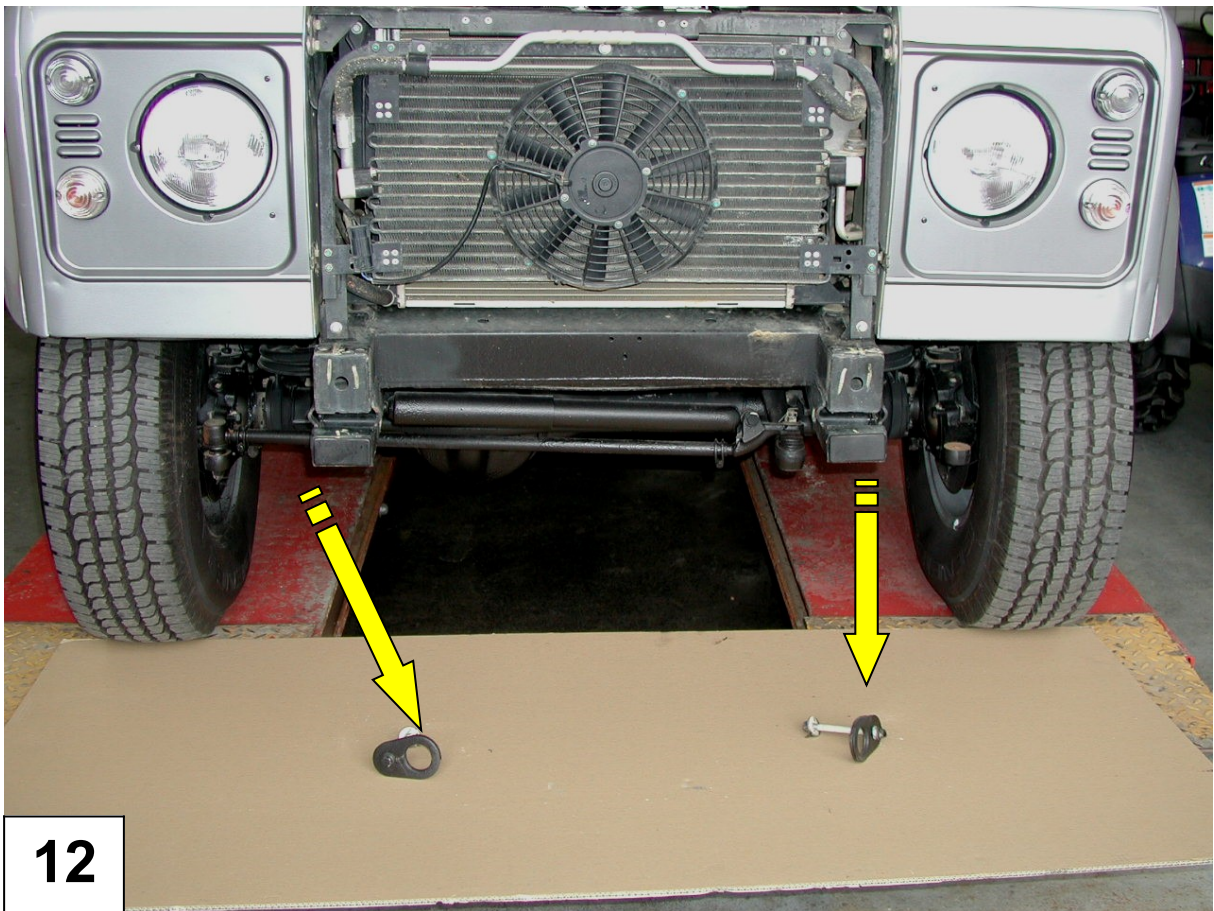
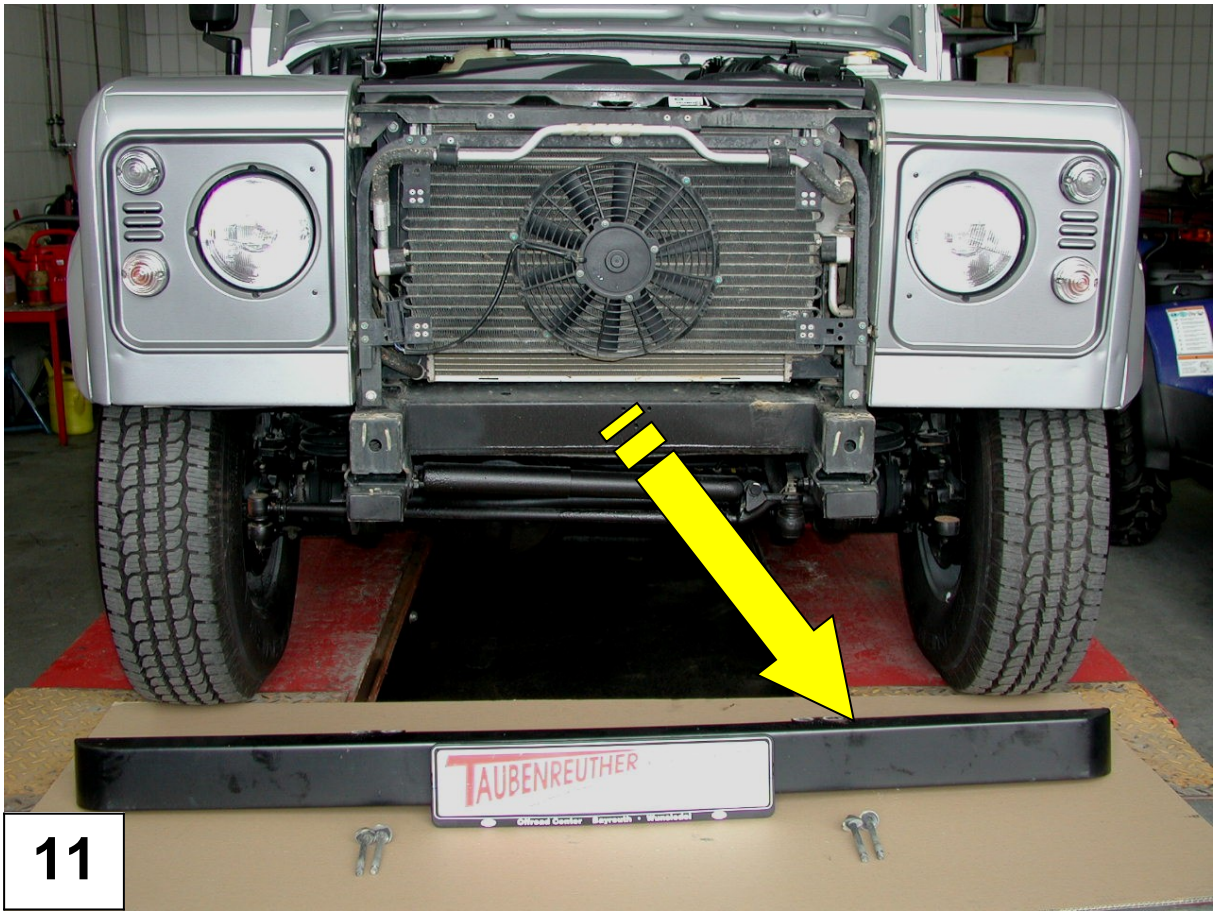

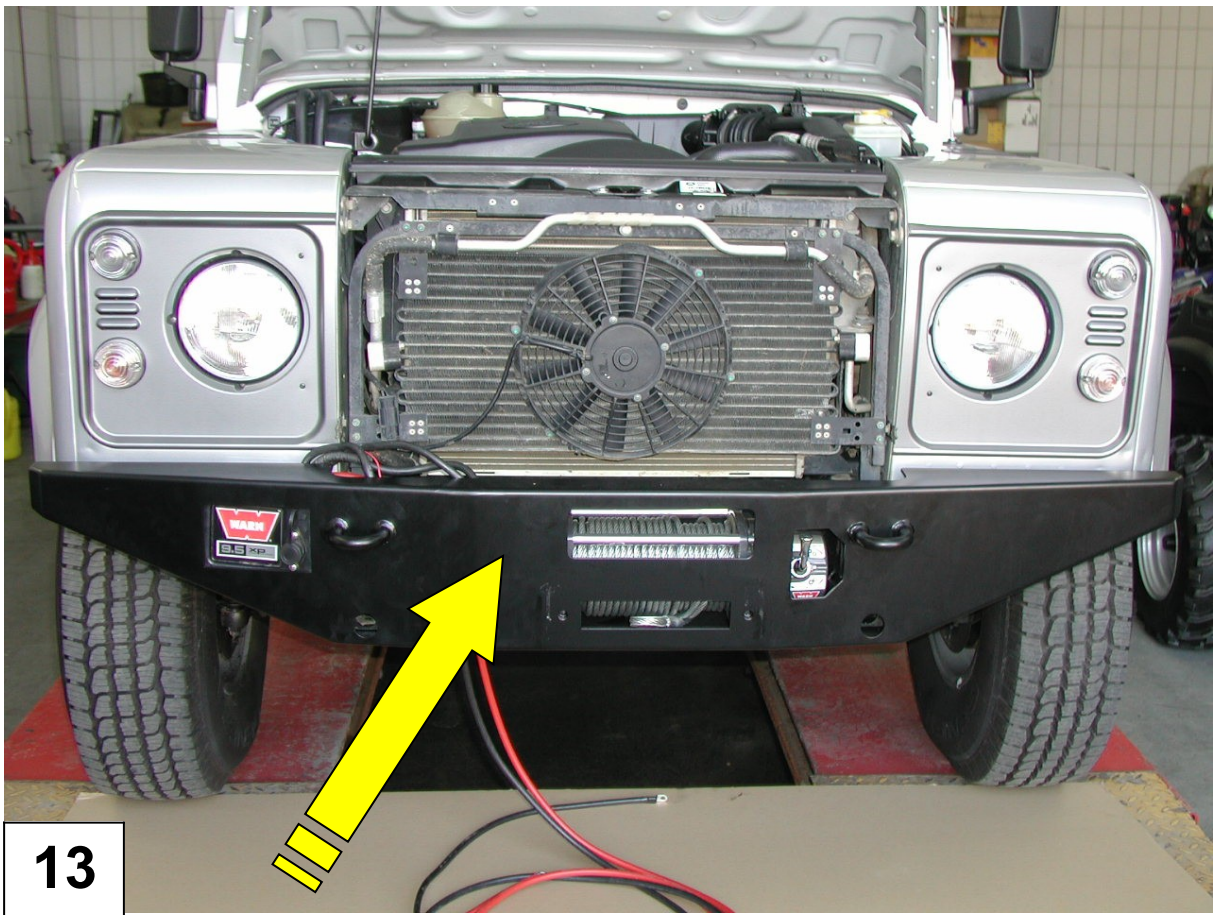

13

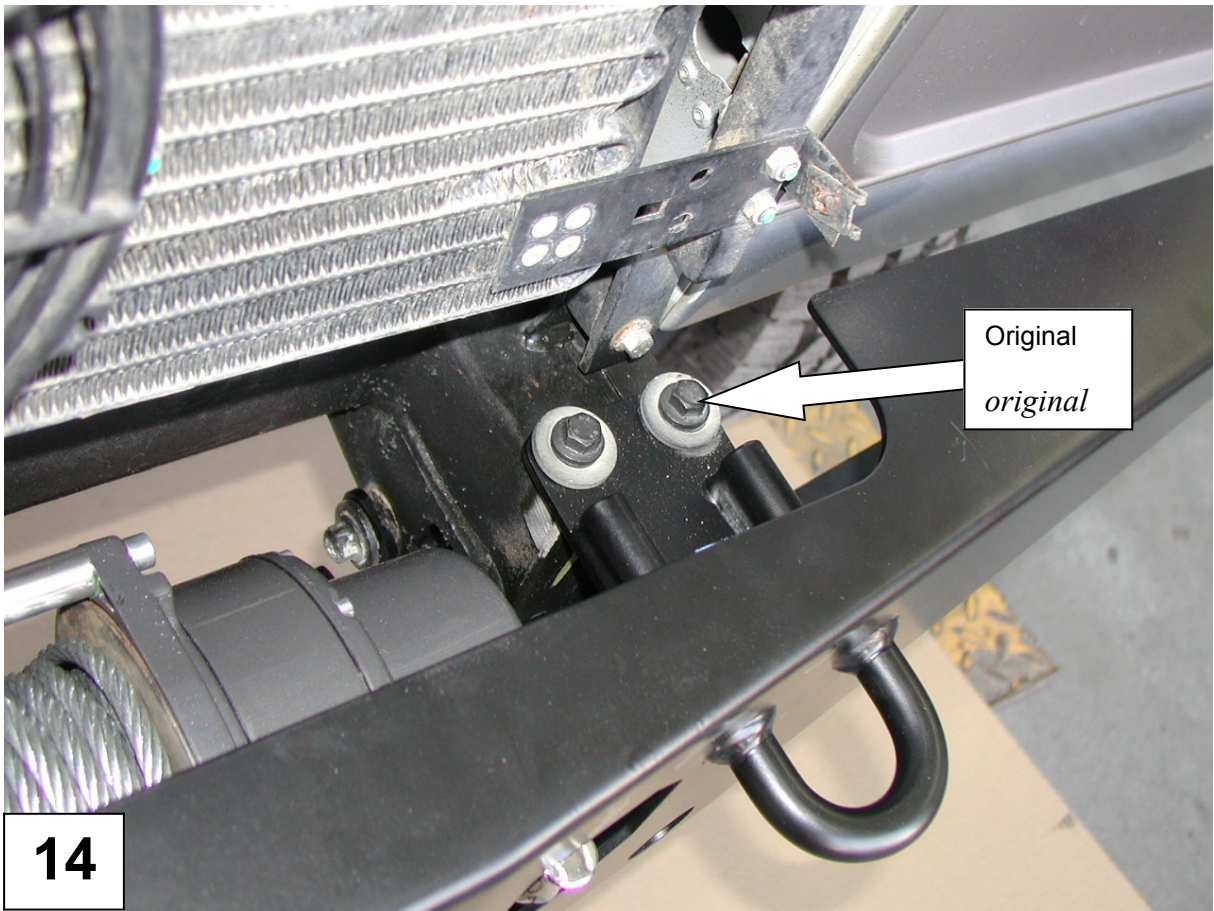

14

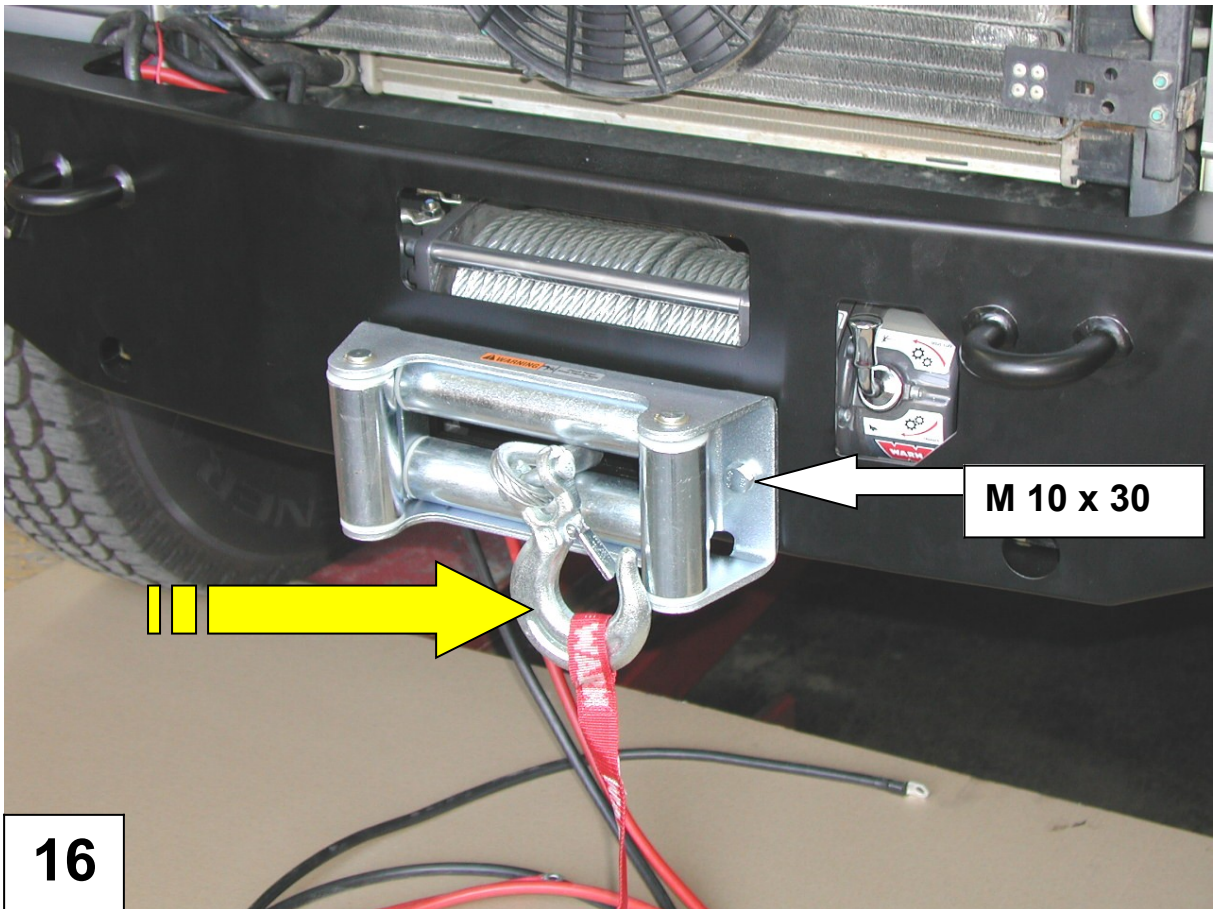
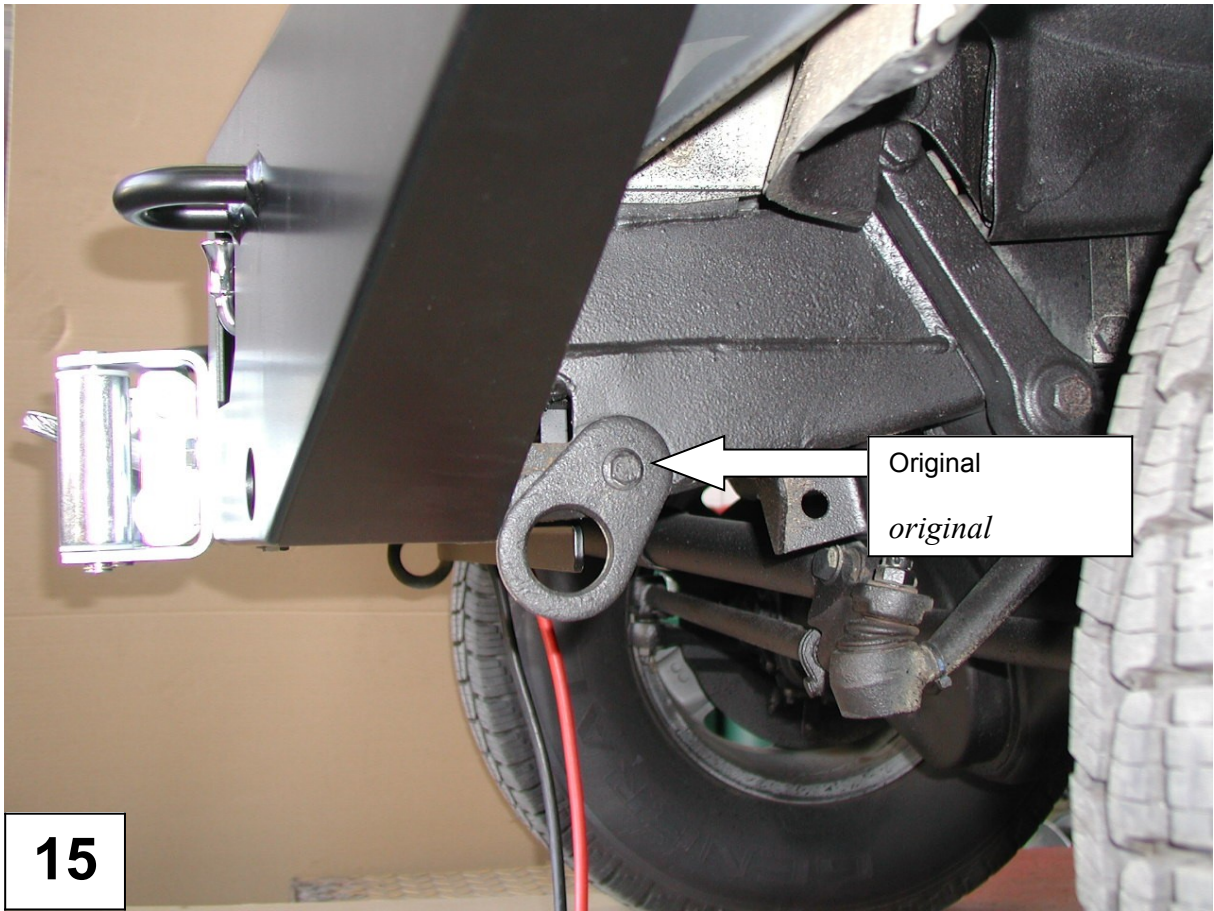

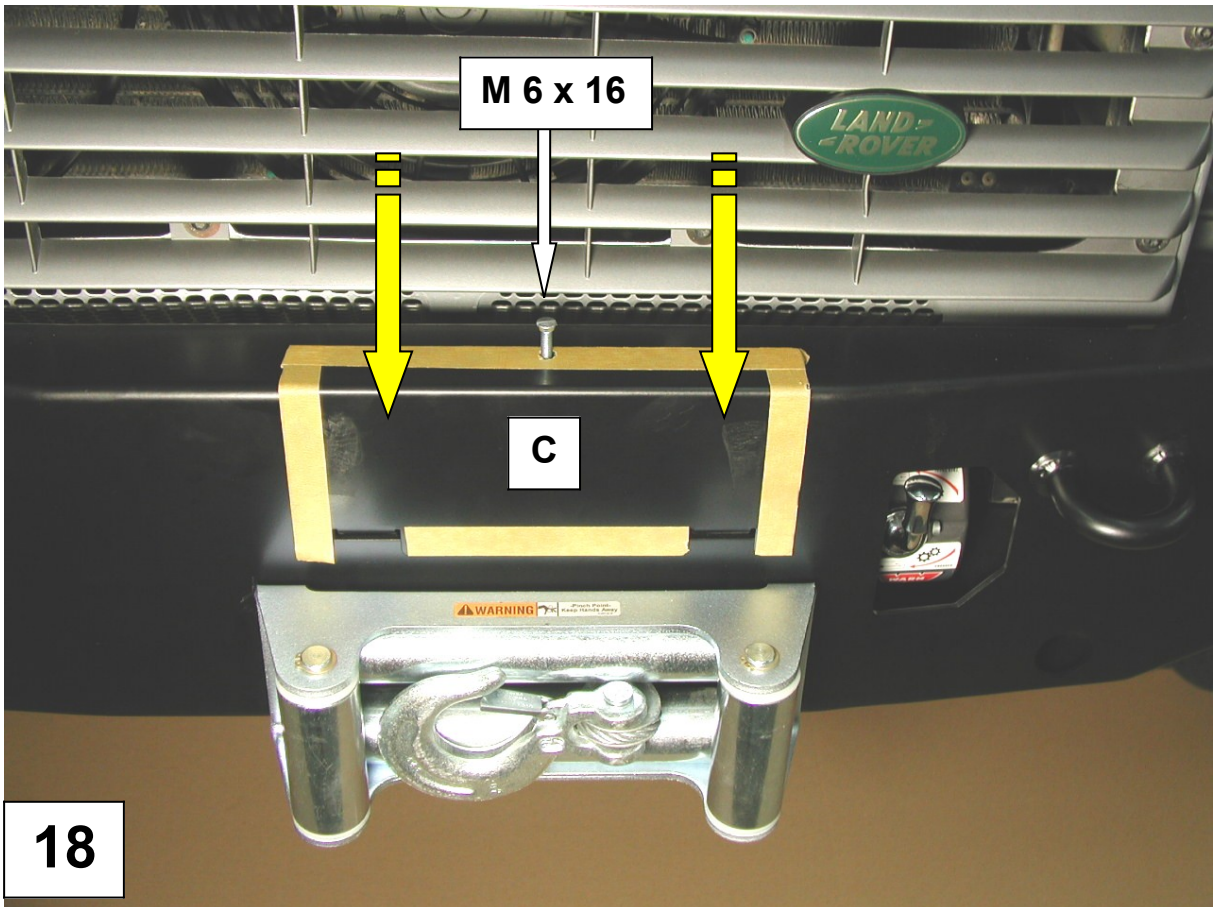
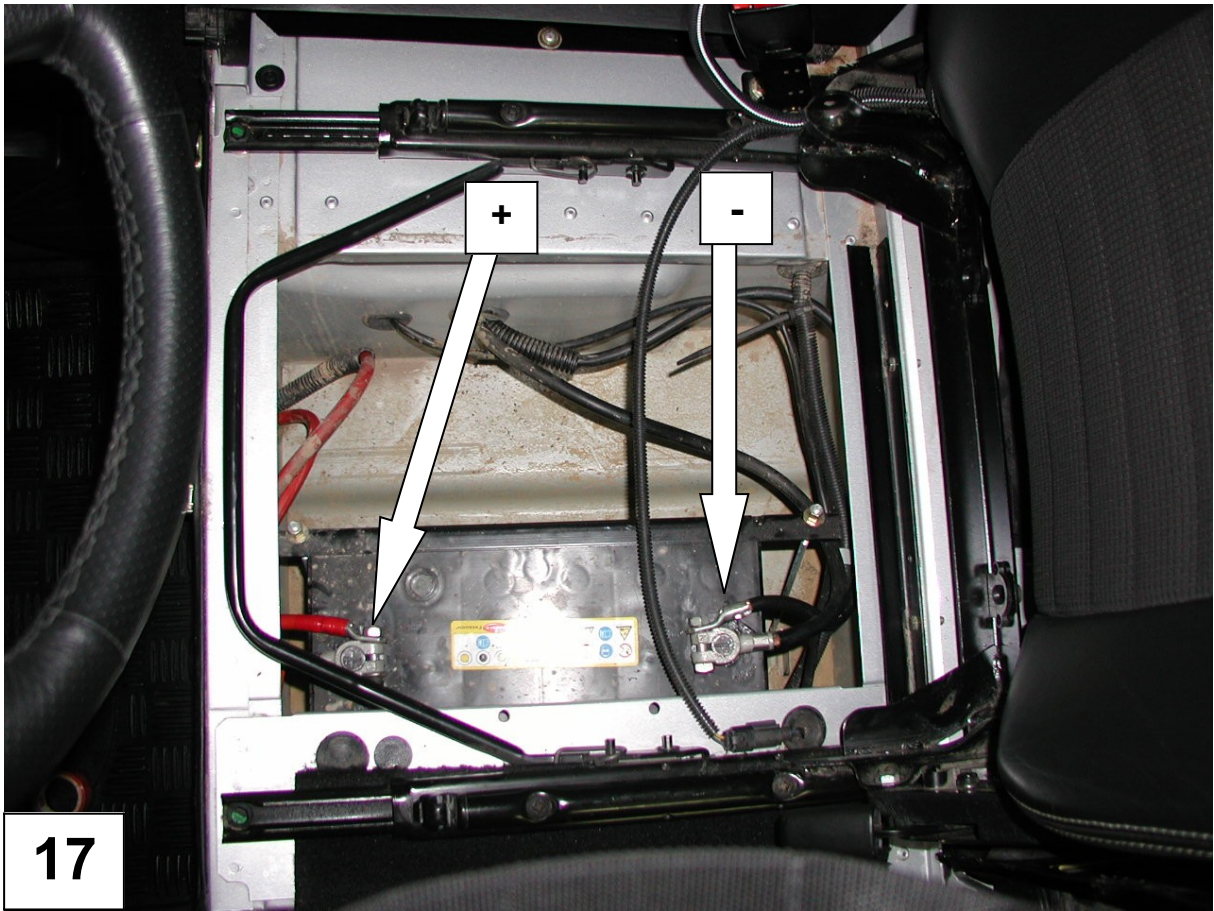



19